FINITE ELEMENT METHOD II

Autumn 2015

Lectures (15h):

1. Accuracy, error estimation and adaptive remeshing
2. Heat flow and thermal stresses in FEM
3. Introduction to structural dynamics, free vibrations
4. Nonlinear problems in mechanics of structures - basic numerical techniques
5. Orthotropic materials and composite structures
6. Parametric modeling and design optimization

Computer lab (15h):

Modeling simple problems of: thermal stresses, contact mechanics, plasticity and residual stresses, free vibrations, buckling, parametric modeling

References:

- [1] Lecture notes from the web site: <http://meil.pw.edu.pl/zwmik/ZWMIK/Dla-studentow2/Finite-Element-Method-II>
- [2] Moaveni S.: *Finite element analysis. Theory and applications with ANSYS*. Paerson Education, 2015.
- [3] Kleiber M. (red.): *Komputerowe metody mechaniki ciał stałych*, seria Mechanika Techniczna XI, Warszawa PWN 1995.
- [4] Xiaolin Chen, Yijun Liuv: *Finite Element Modeling and Simulation with ANSYS*. Workbench, CRC Press 2014
- [5] Huebner K. H., Dewhirst D. L., Smith D.E., Byrom T. G.: *The finite element method for engineers*, J. Wiley & Sons, Inc., 2001.
- [6] Zienkiewicz O.C., Taylor R.: *The Finite Element Method* - different publishers and editions
- [7] Krzesiński G., Zagrajek T., Marek P., Borkowski P.: *MES w mechanice materiałów i konstrukcji. Rozwiązywanie wybranych zagadnień za pomocą programu ANSYS*, Of. Wyd.PW 2015
- [8] Bijak-Żochowski M., Jaworski A., Krzesiński G., Zagrajek T.: *Mechanika Materiałów i Konstrukcji*, Tom 2, Warszawa, Of. Wyd. PW, 2014

Assessment based on the final test and the results of computer lab work

1. ACCURACY OF FE ANALYSIS. ERROR ESTIMATION AND ADAPTIVE REMESHING

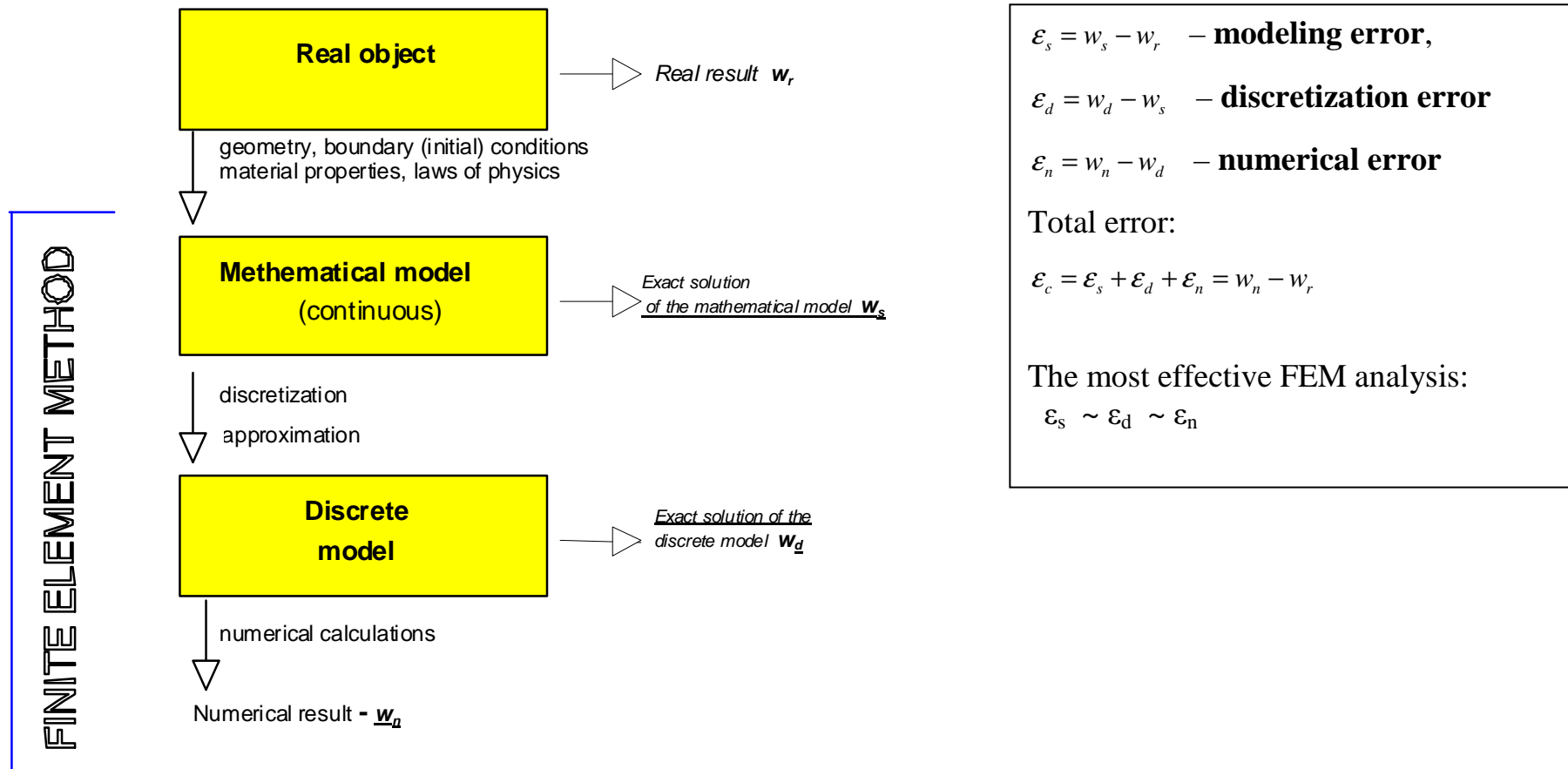

Approximate methods – flow chart

(valid also for other methods e.g. Boundary Element Method - BEM and Finite Differences Method - FDM)

Modeling error ϵ_s

Depends on the accuracy of the available information about the problem and knowledge of the analyst (1D – 2D – 3D models, linear, nonlinear, assumed simplifications, reliable information concerning material properties, loads.)

The example – wooden board

Different models for the problem

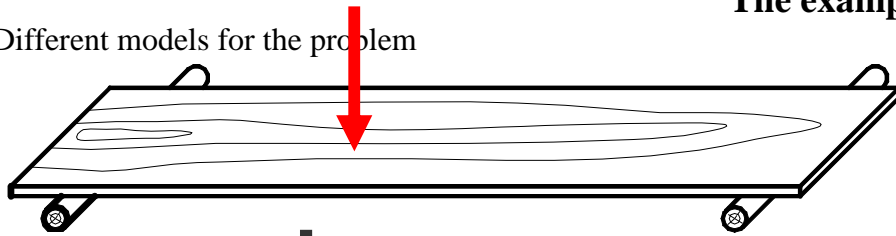

one dimensional model - beam

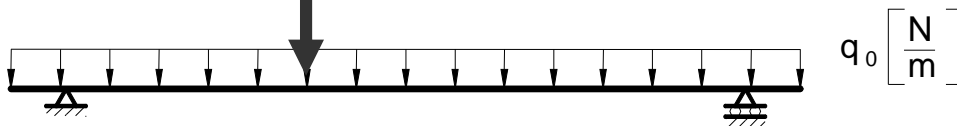

two- dimensional model - plate

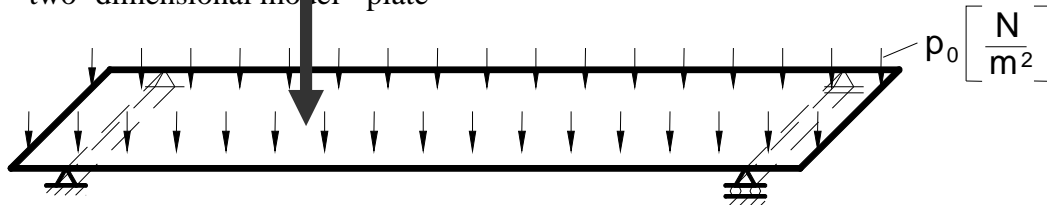

three dimensional model – solid volume

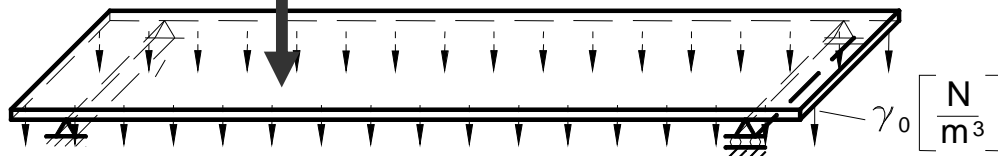

Mathematical model:

- 1, 2, 3 dimensional
- properties of wood: isotropic-orthotropic, moist-dry, homogenous-inhomogeneous, rate dependent-rate-independent
- contact interaction model (friction)
- loadings

Discretization error ϵ_d

Depends on the mesh density, types of the elements – shape functions, the shapes of the finite elements

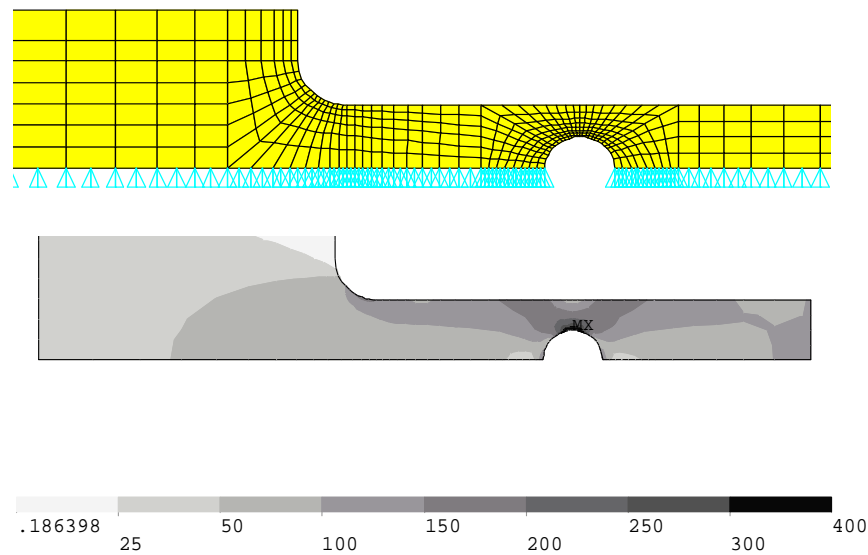

FE mesh and von Mises stress distribution

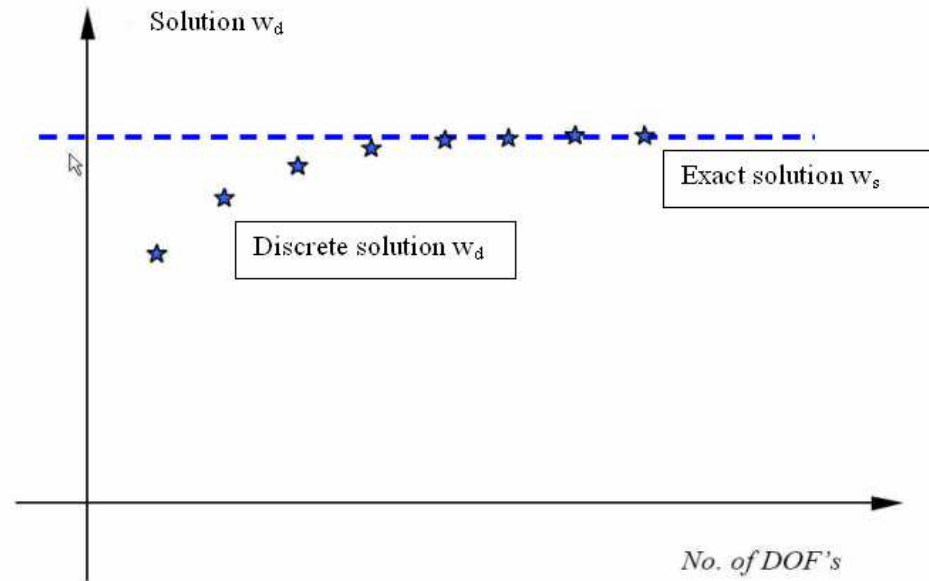

Discrete solution versus exact solution of the continuous problem

There are some mathematical convergence requirements in FEA concerning the mesh, shape functions, and rules of FE model building.

Numerical error ϵ_n

$$[K]\{q\} = \{F\},$$

$$[K + \delta K]\{q + \delta q\} = \{F + \delta F\} \quad \rightarrow \quad \frac{\|\delta q\|}{\|q\|} \leq \| [K] \| \| [K]^{-1} \| \left(\frac{\|\delta F\|}{\|F\|} + \frac{\|\delta K\|}{\|K\|} \right),$$

condition number of the matrix K

$$\text{cond}([K]) = \| [K] \| \| [K]^{-1} \|.$$

Norm of a matrix (vector)– a measure of magnitude

L₂- Euclidean norms

Vector norm $\| \{q\} \| = \left(\sum_i (q_i)^2 \right)^{\frac{1}{2}},$

Matrix norm $\| [K] \| = \left(\sum_j \sum_i (k_{ij})^2 \right)^{\frac{1}{2}}$ (matrix norm induced by the vector norm)

Max norms (L_∞ norms)

$$\| \{q\} \| = \max_i |q_i|, \quad \| [K] \| = \max_i \left(\sum_j |k_{ij}| \right).$$

A problem with a small condition number is said to be **well-conditioned**, while a problem with a high condition number is said to be **ill-conditioned**.

$\text{cond}(K) \geq 1$

$\text{cond}(K) \approx 1$ - problem well-conditioned

$\text{cond}(K) \gg 1$ - problem ill-conditioned

Reasons of ill-conditioning of the problems in FE stress analysis – great differences between stiffness of FE elements, unstable boundary conditions

The example (ill conditioned problem):

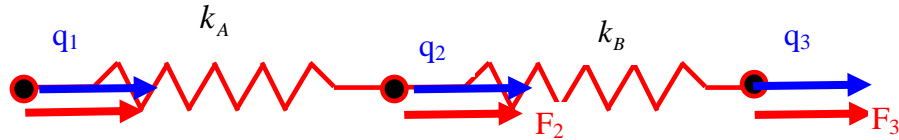

$$[k]_e = \begin{bmatrix} k & -k \\ -k & k \end{bmatrix}_{2 \times 2} \quad \begin{bmatrix} k_A & -k_A \\ -k_A & k_A + k_B & -k_B \\ & -k_B & k_B \end{bmatrix} \begin{Bmatrix} q_1 \\ q_2 \\ q_3 \end{Bmatrix} = \begin{Bmatrix} F_1 \\ F_2 \\ F_3 \end{Bmatrix}$$

$$q_1 = 0 \quad \begin{bmatrix} k_A + k_B & -k_B \\ -k_B & k_B \end{bmatrix} \begin{Bmatrix} q_2 \\ q_3 \end{Bmatrix} = \begin{Bmatrix} F_2 \\ F_3 \end{Bmatrix}$$

Let's assume: $k_A = 1$ $k_B = 1000$

$$\begin{Bmatrix} F_2 \\ F_3 \end{Bmatrix} = \begin{Bmatrix} 1 \\ -1 \end{Bmatrix}$$

The solution:

$$\begin{Bmatrix} q_2 \\ q_3 \end{Bmatrix} = \begin{bmatrix} \frac{1}{k_A} & \frac{1}{k_A} \\ \frac{1}{k_A} & \frac{1}{k_A} + \frac{1}{k_B} \end{bmatrix} \begin{Bmatrix} F_2 \\ F_3 \end{Bmatrix}$$

The result:

$$\begin{Bmatrix} q_2 \\ q_3 \end{Bmatrix} = \begin{Bmatrix} 0 \\ -0.001 \end{Bmatrix}$$

The example of the very small perturbation

For changed force vector : $\begin{Bmatrix} F_2 \\ F_3 \end{Bmatrix} = \begin{Bmatrix} 0.999 \\ -1.0 \end{Bmatrix}$

$$\begin{Bmatrix} q_2 \\ q_3 \end{Bmatrix} = \begin{Bmatrix} -0.001 \\ -0.002 \end{Bmatrix}$$

$$\{\delta F\} = \begin{Bmatrix} \delta F_2 \\ \delta F_3 \end{Bmatrix} = \begin{Bmatrix} -0.001 \\ 0 \end{Bmatrix} \quad \{\delta q\} = \begin{Bmatrix} \delta q_2 \\ \delta q_3 \end{Bmatrix} = \begin{Bmatrix} -0.001 \\ -0.001 \end{Bmatrix}$$

$$\frac{\|\delta F\|}{\|F\|} = 0.707 \cdot 10^{-3} \Rightarrow \frac{\|\delta q\|}{\|q\|} = 1.414$$

$cond(K) \approx 4 \cdot 10^3$

First equation

$$q_3 = \frac{k_A + k_B}{k_B} \cdot q_2 - \frac{F_2}{k_B}$$

Second equation

$$q_3 = q_2 + \frac{F_3}{k_B}$$

System ill-conditioned if

$$\frac{k_A + k_B}{k_B} \rightarrow 1$$

$$\frac{k_A}{k_B} \rightarrow 0$$

Sensitivity to the slop change

$K_A \ll K_B$ **system ill conditioned**

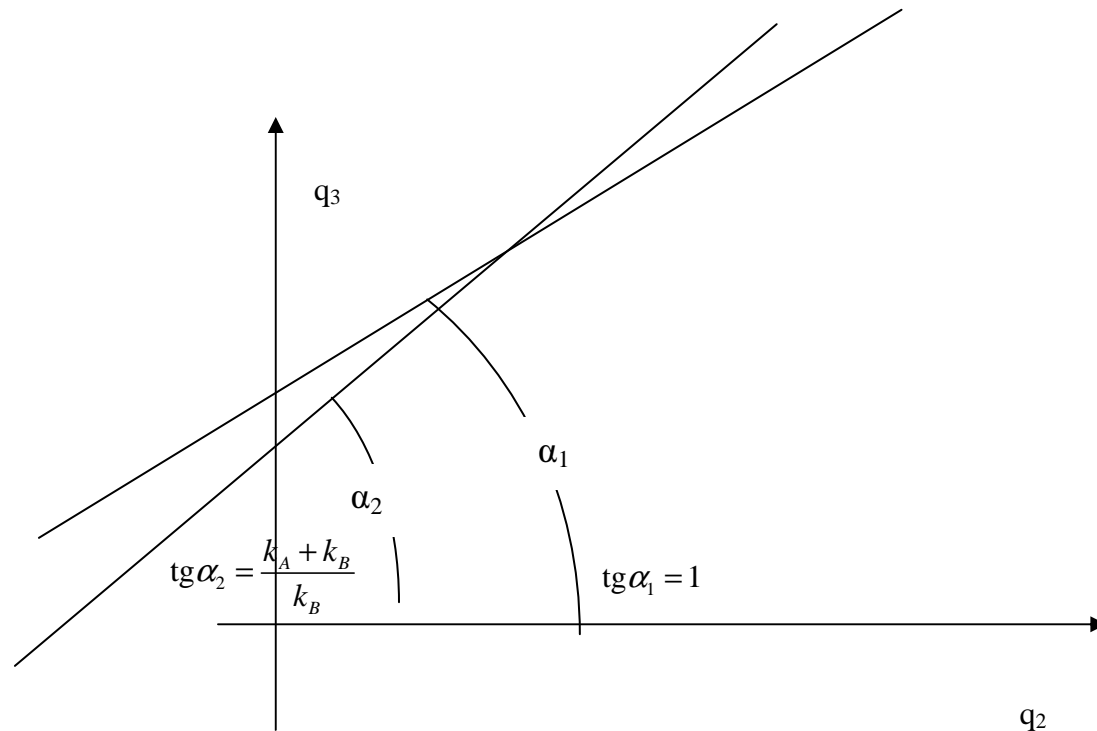

Round-off error

As a general rule, if the condition number $\text{cond}(K) = 10^k$, then you may lose up to maximum k digits of accuracy during the solution of the system of linear equations. However, the condition number does not give the exact value of the maximum inaccuracy that may occur in the algorithm.

$$r \geq p - \log_{10}(\text{cond}([K]))$$

p – number of significant digits in the computer representation of numbers

r – number of significant digits of the result

In FE models $\text{cond}(K)$ reaches 10^8

A posteriori error approximation techniques

Element and nodal solution in FE program postprocessors (PLESOL, PLNSOL in ANSYS)

FE solution provides the continuous displacement field (from element to element), and the discontinuous stress field.

To obtain smooth stress distribution, the averaging of the stresses in the nodes is performed (*nodal stresses*).

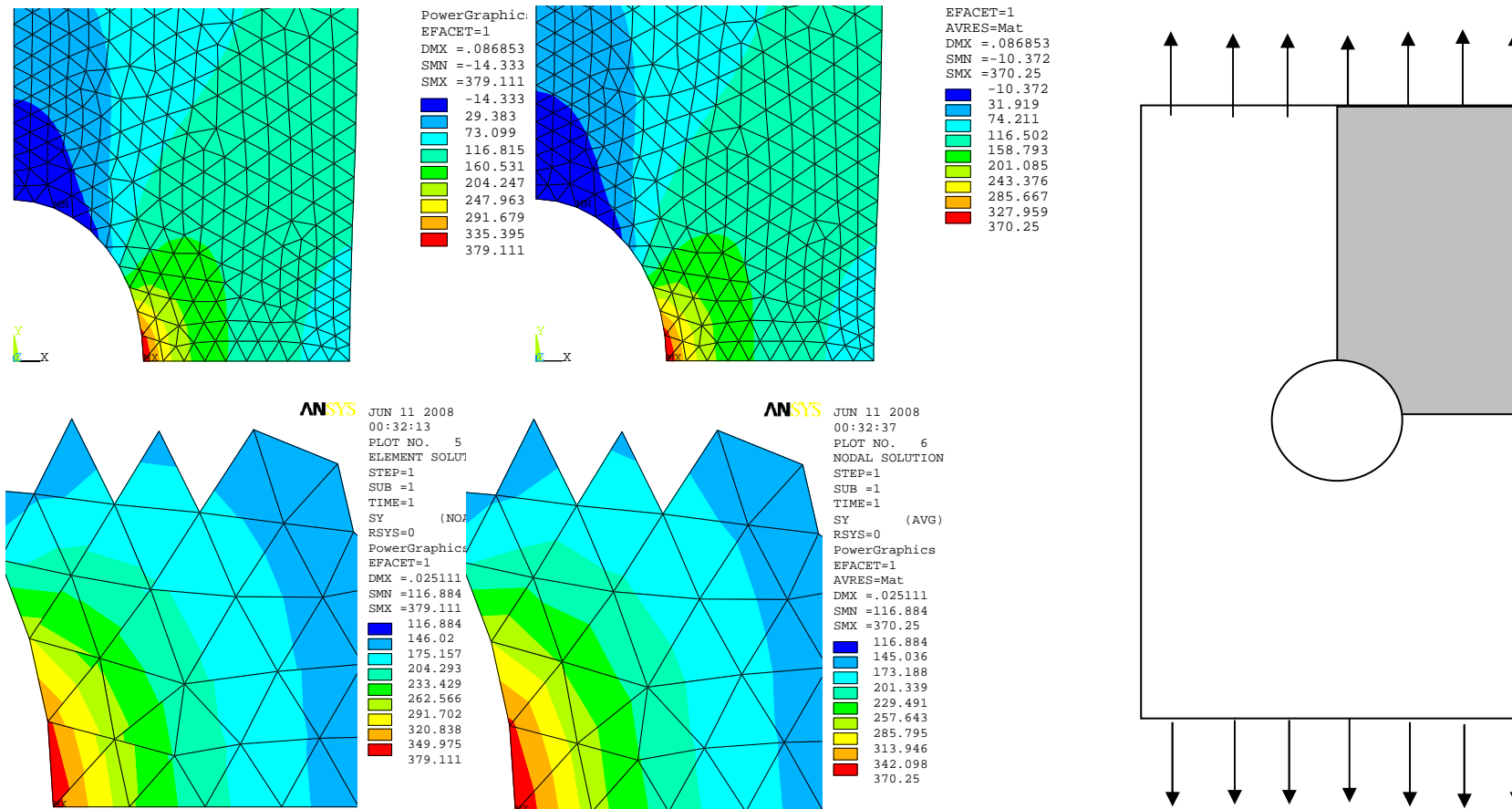

Rectangular plate with a hole under tension. The model of the quarter of the structure. The stress component σ_y Discontinuous „element solution” (left) and averaged continuous “nodal solution” (right). Six-node triangular plane elements

Basic relations between displacements, strains, stresses and strain energy within finite elements (the relations discussed during FEM I lectures)

Displacement field over the element is interpolated from the nodal displacements:

$$\{u\} = [N(x, y, z)] \{q\}_e, \text{ where } \{q\}_e - \text{nodal displacements vector, } [N] - \text{shape functions matrix.}$$

For example for the simplest triangular element with 3 nodes and 6 DOF the relation

$$\begin{Bmatrix} u(x, y) \\ v(x, y) \end{Bmatrix} = \begin{bmatrix} N_1(x, y) & 0 & N_2(x, y) & 0 & N_3(x, y) & 0 \\ 0 & N_1(x, y) & 0 & N_2(x, y) & 0 & N_3(x, y) \end{bmatrix} \begin{Bmatrix} u_1 \\ v_1 \\ u_2 \\ v_2 \\ u_3 \\ v_3 \end{Bmatrix},$$

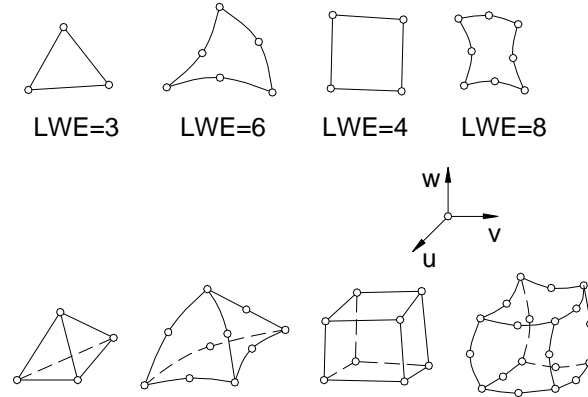

where N_i are the linear functions

Shape functions N_{ij} are usually polynomials defined in local (element) coordinate systems.

Displacements, strains and stresses within each element are defined as the functions of the nodal displacements

$$\{u\} = [N] \{q\}_e,$$

$$\{\varepsilon\} = [R] \{u\} = [R][N] \{q\}_e = [B] \{q\}_e, \text{ [B] - strain-displacement matrix, [R] - gradient matrix}$$

$$\{\sigma\} = [D] \{\varepsilon\} = [D][B] \{q\}_e.$$

The strain energy of the element Ω_e is:

$$U_e = \frac{1}{2} \int_{\Omega_e} [\varepsilon] \{\sigma\} d\Omega_e, \quad U_e = \frac{1}{2} \int_{\Omega_e} [q]_e [B]^T [D] [B] \{q\}_e d\Omega_e, \quad U_e = \frac{1}{2} [q]_e [k]_e \{q\}_e.$$

where $[k]_e = \int_{\Omega_e} [B]^T [D] [B] d\Omega_e$ is the **stiffness matrix of the element** (symmetrical, singular, semi-positive defined)

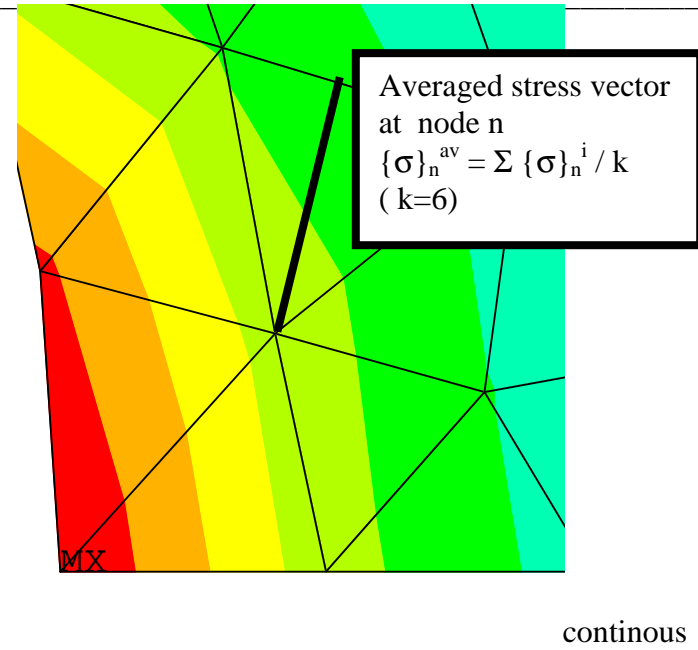
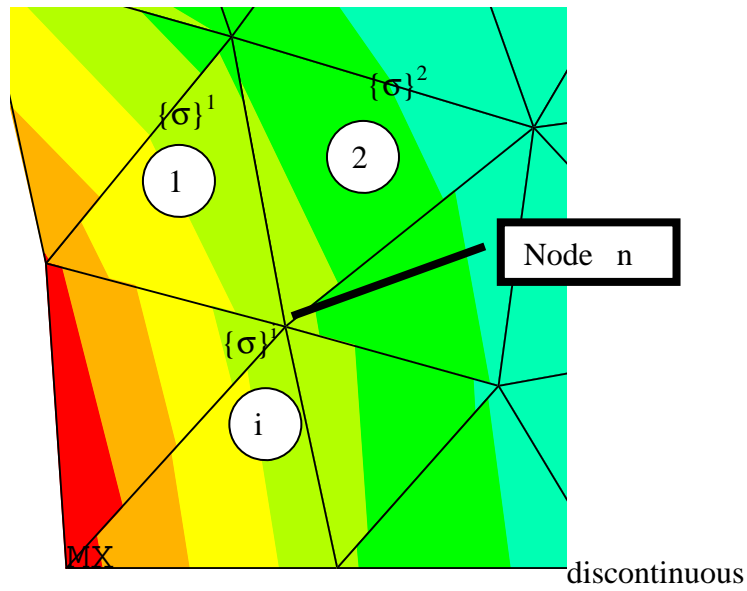

stress vector at node n of element i

$$\{\sigma\}_n^i = \begin{Bmatrix} \sigma_x \\ \sigma_y \\ \sigma_z \\ \tau_{xy} \\ \tau_{yz} \\ \tau_{xz} \end{Bmatrix}_n \quad \{\sigma\}_n^1 \neq \{\sigma\}_n^2 \neq \{\sigma\}_n^3 \neq \dots$$

averaged stress vector at node n:

$$\{\sigma\}_n^{av} = \frac{\sum_{i=1}^k \{\sigma\}_n^i}{k}$$

Stress error vector at node n of element i $\{\Delta\sigma\}_n^i = \{\sigma\}_n^i - \{\sigma\}_n^{av}$

The stress error vector $\{\Delta\sigma\}^i$ within the element 'i' may be determined by standard approximation using the stress error vectors at nodes of element i $\{\Delta\sigma\}_n^i$.

Then for each element so called energy error can be estimated

$$e_i = \frac{1}{2} \int_{\Omega_i} [\Delta\sigma]^i [D]^{-1} \{\Delta\sigma\}^i d\Omega_i \quad (\text{ETABLE-SERR})$$

Strain energy of the element i

$$U_i = \frac{1}{2} \int_{\Omega_i} [\sigma]^i \{\varepsilon\}^i d\Omega_i$$

$\{\varepsilon\} = [D]^{-1} \{\sigma\}$, D] – stress-strain matrix

$$U_i = \frac{1}{2} \int_{\Omega_i} [\sigma]^i [D]^{-1} \{\sigma\}^i d\Omega_i$$

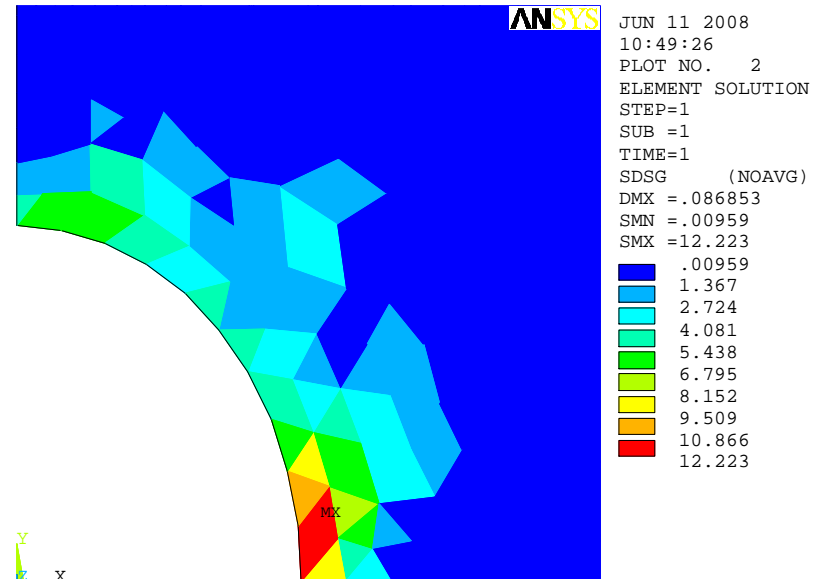
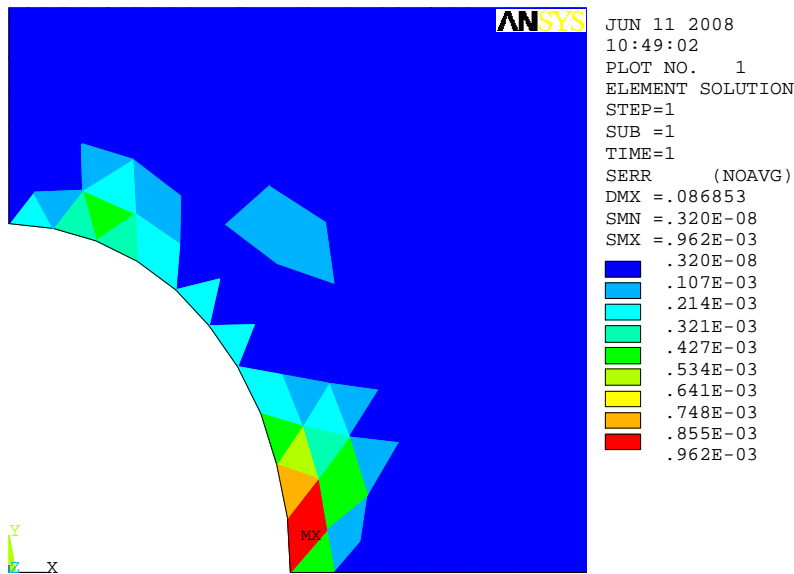

Initial mesh. SERR and SDSG error distribution

SDSG - $\Delta\sigma_i = \text{maximum absolute value of any component of } \{\Delta\sigma\}_n^i = \{\sigma\}_n^i - \{\sigma\}_n^{av} \text{ for all nodes connected to element}$

The energy error over the model

$$e = \sum_{i=1}^{l.el.} e_i$$

The energy error can be normalized against the strain energy

$$SEPC = 100 \left(\frac{e}{U + e} \right)^{\frac{1}{2}}$$

U – total strain energy over the entire model

SEPC – percentage error in energy norm

The e_i values can be used for adaptive mesh refinement. It has been shown that if e_i is equal for all elements, then the model using the given number of elements is the most efficient one.

This concept is also referred to as “error equilibration” ($e_i = \text{const}$, $SEPC < S_0$).

Adaptive Meshing Techniques

- Automatic refinement of FE meshes until converged results are obtained
- User's responsibility reduced to generation a good initial mesh

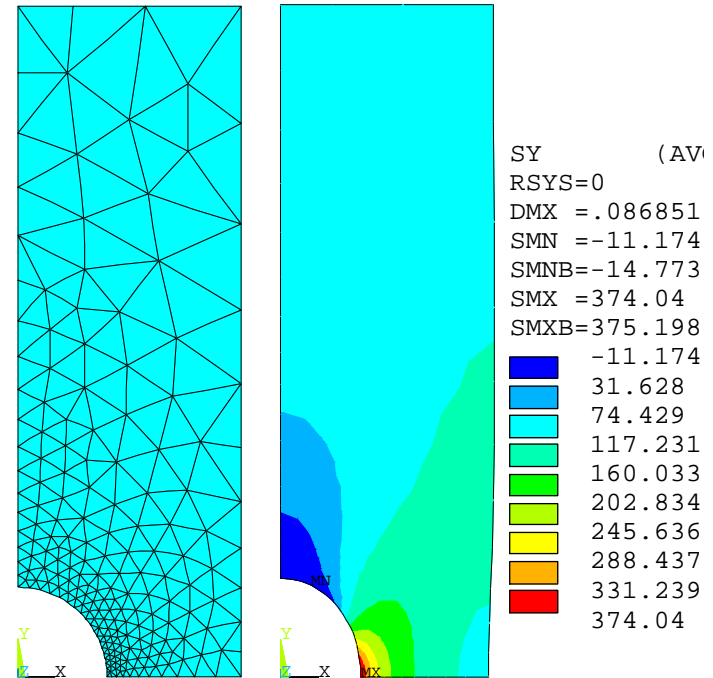
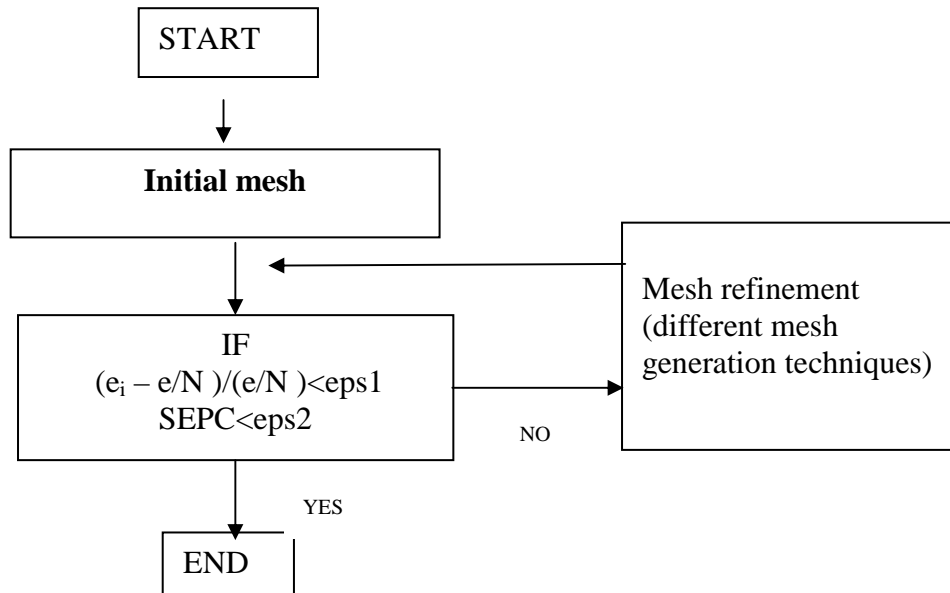

Final FE mesh and the results - Sy distribution (percentage error in energy norm SEPC=0.811 %, uniform error distribution e_i= const)

Selective adaptive meshing

If mesh discretization error (measured as a percentage) is relatively unimportant in some regions of the model, the procedure may be speed up by excluding such regions from the adaptive meshing operations. Also - near singularities caused by concentrated loads and at boundaries between different materials.

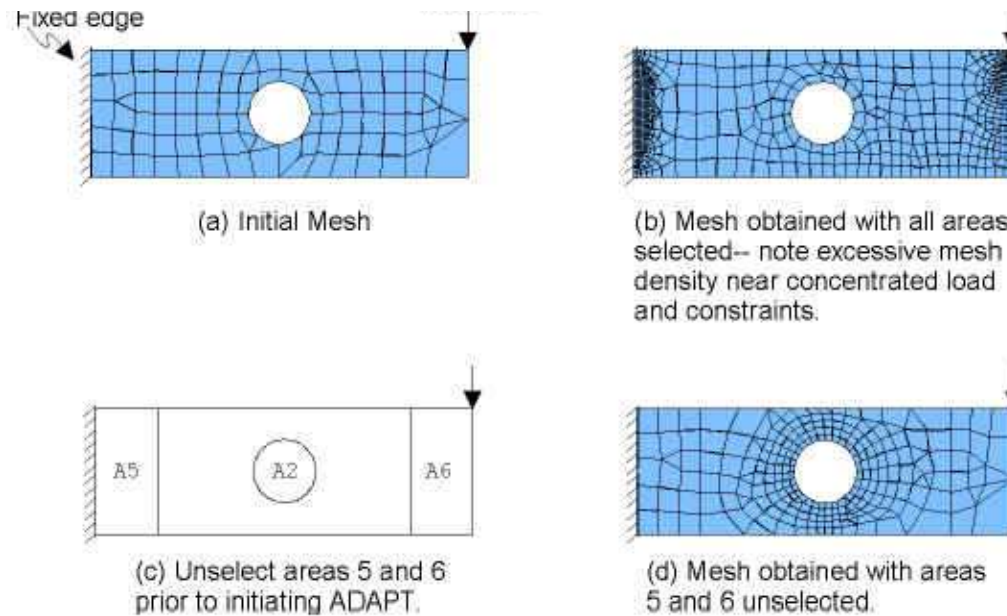

Selective adaptive meshing
in ANSYS

Types of refinement in adaptive meshing :

h-refinement: reduction of the size of the element (“*h*” refers to the typical size of the elements)

p-refinement: increase of the order of the polynomials on an element (shape functions from linear to quadratic, etc.)

r-refinement: re-arrangement of the nodes in the mesh

hp-refinement: combination of the *h*- and *p*-refinements.